

Winsem Technology Corp.

## 650V N-Channel Power MOSFET

### Features

- High Voltage:  $BV_{DSS}=650V(\text{Min.})$
- $I_D : 4A$
- Robust high voltage termination
- Avalanche energy specified
- Fast diode recovery time

### Application

- Ballast Bridge
- Switch Mode Power Supplier
- Power Factor Correction
- Lighting

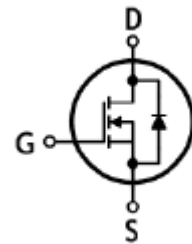
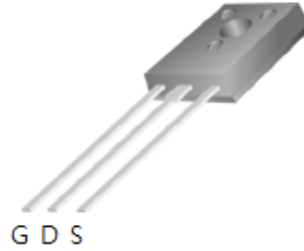

### Ordering Information

Type NO	Marking	Package Code
WMM4N65S	4N65M	TO-126F

### Absolute maximum ratings ( $T_C=25^\circ\text{C}$ unless otherwise noted)

Characteristic	Symbol	Rating	Unit	
Drain-source voltage	$V_{DSS}$	650	V	
Gate-source voltage	$V_{GSS}$	$\pm 30$	V	
Drain current (DC) *	$I_D$	$T_C=25^\circ\text{C}$	4.0	A
		$T_C=100^\circ\text{C}$	3.2	A
Drain current (Pulsed) *	$I_{DM}$	16	A	
Single avalanche energy ②	$E_{AS}$	86.7	mJ	
Repetitive avalanche current ①	$I_{AR}$	2.5	A	
Repetitive avalanche energy ①	$E_{AR}$	3.2	mJ	
Power dissipation	$P_D$	48	W	
Junction temperature	$T_J$	150	$^\circ\text{C}$	
Storage temperature range	$T_{stg}$	-55~150	$^\circ\text{C}$	

\* Limited by maximum junction temperature

Characteristic	Symbol	Typ.	Unit	
Thermal resistance	Junction-case	$R_{th(J-C)}$	1.67	$^\circ\text{C}/\text{W}$
	Junction-ambient	$R_{th(J-A)}$	62.5	

**Electrical Characteristics** ( $T_C=25^\circ\text{C}$  unless otherwise noted)

Characteristic	Symbol	Test Condition	Min.	Typ.	Max.	Unit
Drain-source breakdown voltage	$BV_{DSS}$	$I_D=250\ \mu\text{A}$ , $V_{GS}=0\text{V}$	650	-	-	V
Gate threshold voltage	$V_{GS(th)}$	$I_D=250\ \mu\text{A}$ , $V_{DS}=V_{GS}$	2.0	-	4.0	V
Drain-source cut-off current	$I_{DSS}$	$V_{DS}=650\text{V}$ , $V_{GS}=0\text{V}$ , $T_C=25^\circ\text{C}$	-	-	1	$\mu\text{A}$
		$V_{DS}=520\text{V}$ , $V_{GS}=0\text{V}$ , $T_C=125^\circ\text{C}$	-	-	100	$\mu\text{A}$
Gate leakage current	$I_{GSS}$	$V_{DS}=0\text{V}$ , $V_{GS}=\pm 20\text{V}$	-	-	$\pm 10$	$\mu\text{A}$
Drain-source on-resistance	$R_{DS(on)}$	$V_{GS}=10\text{V}$ , $I_D=2\text{A}$	-	2.3	2.8	$\Omega$
Forward transfer conductance ③	$g_{fs}$	$V_{DS}=15\text{V}$ , $I_D=2\text{A}$	-	4	-	S
Input capacitance	$C_{iss}$	$V_{DS}=25\text{V}$ , $V_{GS}=0\text{V}$ $f=1\ \text{MHz}$	-	550	-	pF
Output capacitance	$C_{oss}$		-	53	-	
Reverse transfer capacitance	$C_{rss}$		-	8.3	-	
Turn-on delay time ③④	$t_{d(on)}$	$V_{DD}=325\text{V}$ , $I_D=4\text{A}$ $R_G=10\Omega$	-	8.4	-	ns
Rise time ③④	$t_r$		-	6.3	-	
Turn-off delay time ③④	$t_{d(off)}$		-	30	-	
Fall time ③④	$t_f$		-	8.5	-	
Total gate charge ③④	$Q_g$	$V_{DD}=520\text{V}$ , $V_{GS}=10\text{V}$ $I_D=4\text{A}$	-	14	15	nC
Gate-source charge ③④	$Q_{gs}$		-	3	-	
Gate-drain charge ③④	$Q_{gd}$		-	6.2	-	

**Source-Drain Diode Ratings and Characteristics** ( $T_C=25^\circ\text{C}$  unless otherwise noted)

Characteristic	Symbol	Test Condition	Min	Typ	Max	Unit
Source current (DC)	$I_S$	Integral reverse diode in the MOSFET	-	-	4.0	A
Source current (Pulsed)	$I_{SM}$		-	-	16.0	
Forward voltage	$V_{SD}$	$V_{GS}=0\text{V}$ , $I_{SD}=4\text{A}$	-	-	1.4	V
Reverse recovery time ③④	$t_{rr}$	$I_{SD}=4\text{A}$ , $V_{GS}=0\text{V}$	-	430	-	ns
Reverse recovery charge ③④	$Q_{rr}$	$dI_F/dt=100\text{A}/\mu\text{s}$	-	1.28	-	$\mu\text{C}$

Note ;

1. Repetitive rating : Pulse width limited by safe operating area
2.  $L=10\text{mH}$ ,  $I_{AS}=4\text{A}$ ,  $V_{DD}=50\text{V}$ ,  $R_G=25\ \Omega$ , Starting  $T_J=25^\circ\text{C}$
3. Pulse Test : Pulse width  $\leq 300\ \mu\text{s}$ , Duty cycle  $\leq 2\%$
4. Essentially independent of operating temperature typical characteristics

Electrical Characteristic Curves

Fig. 1 Typical Output Characteristics

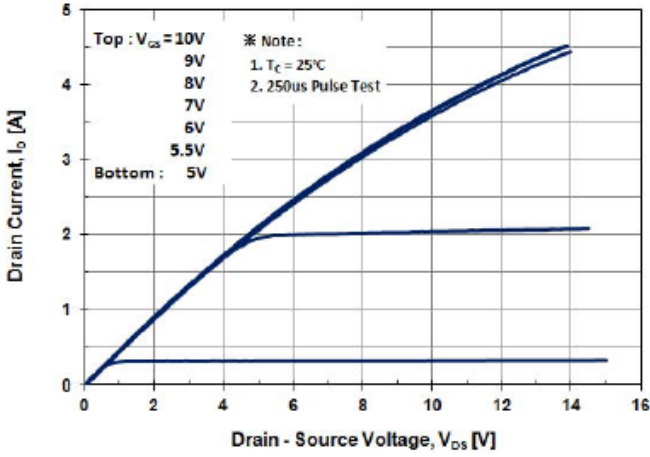

Fig. 2 Typical Output Characteristics

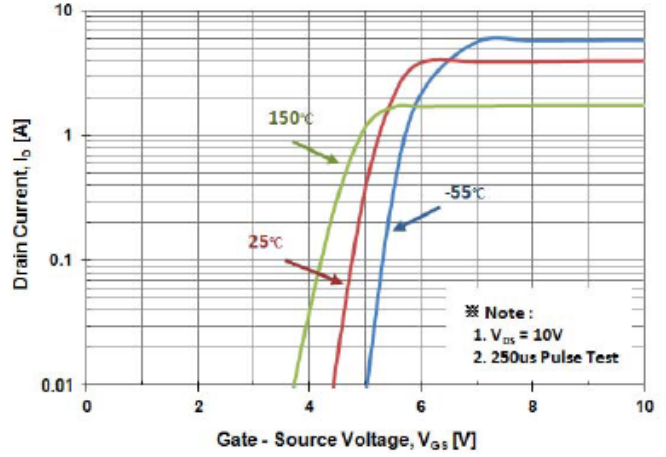

Fig. 3 On-Resistance Variation with Drain Current and Gate Voltage

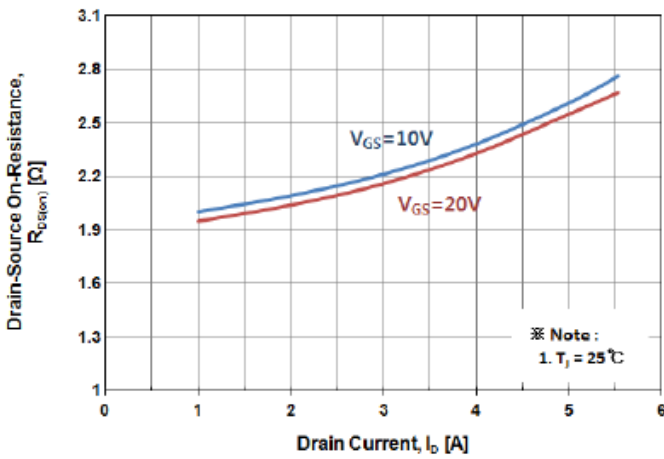

Fig. 4 Body Diode Forward Voltage Variation with Source Current

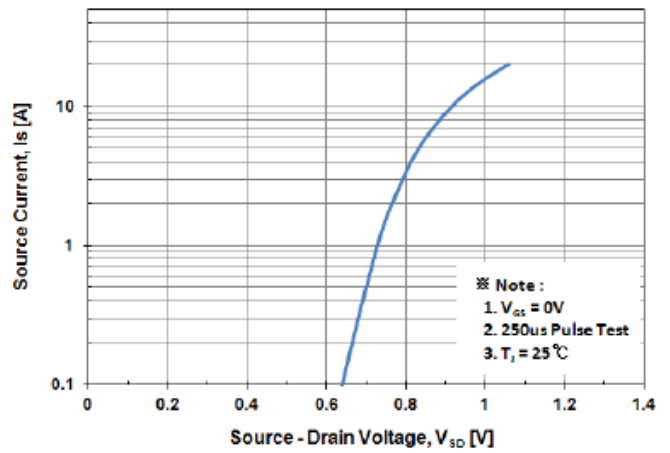

Fig. 5 Typical Capacitance Characteristics

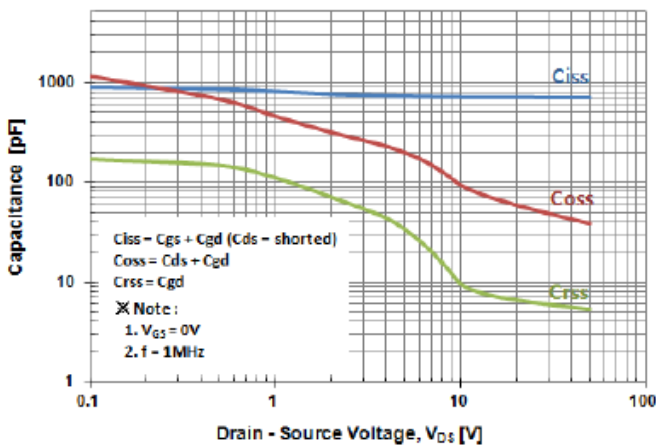
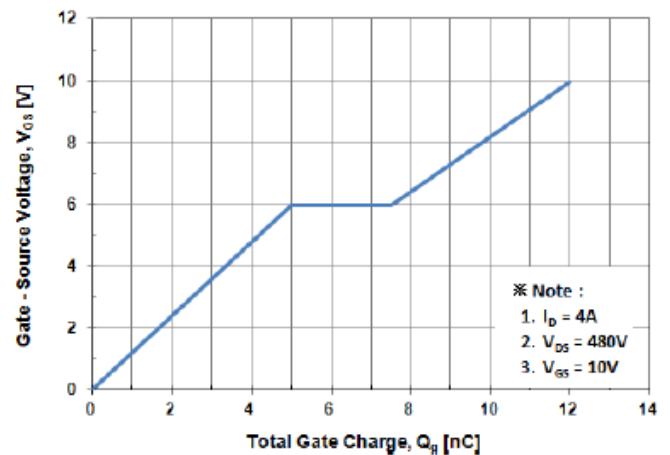

Fig. 6 Typical Total Gate Charge Characteristics



Electrical Characteristic Curves

Fig. 7 Breakdown Voltage Variation vs. Temperature

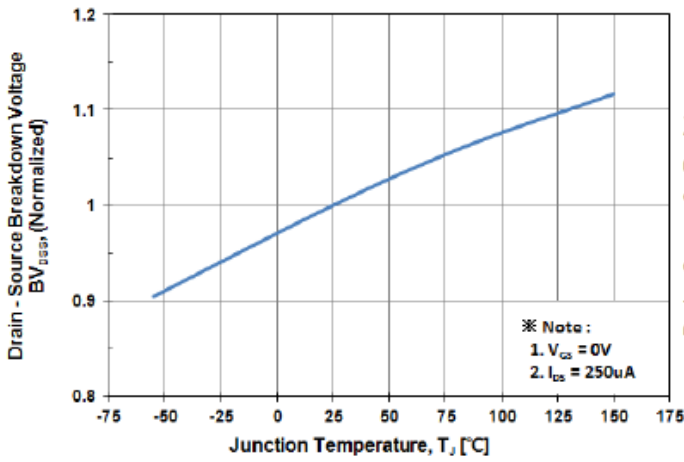

Fig. 8 On-Resistance Variation vs. Temperature

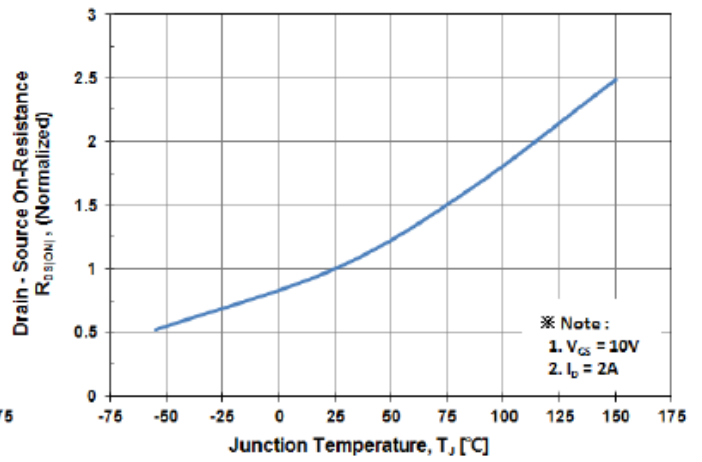

Fig. 9 Maximum Drain Current vs. Case Temperature

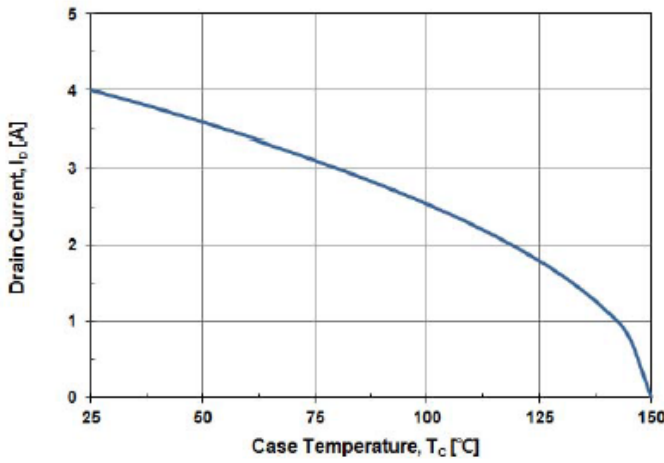

Fig. 10 Maximum Safe Operating Area

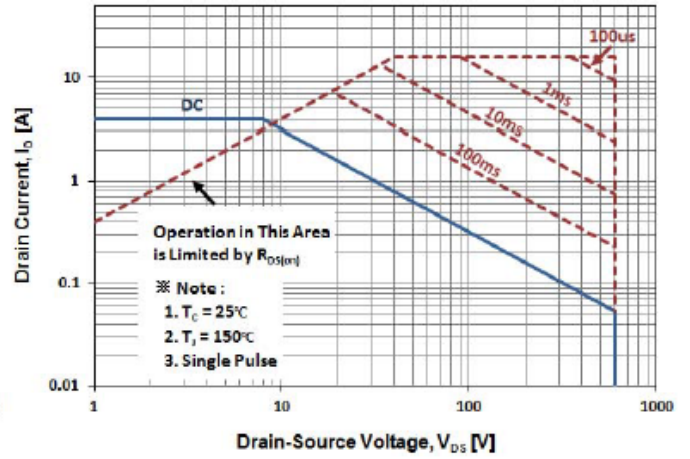
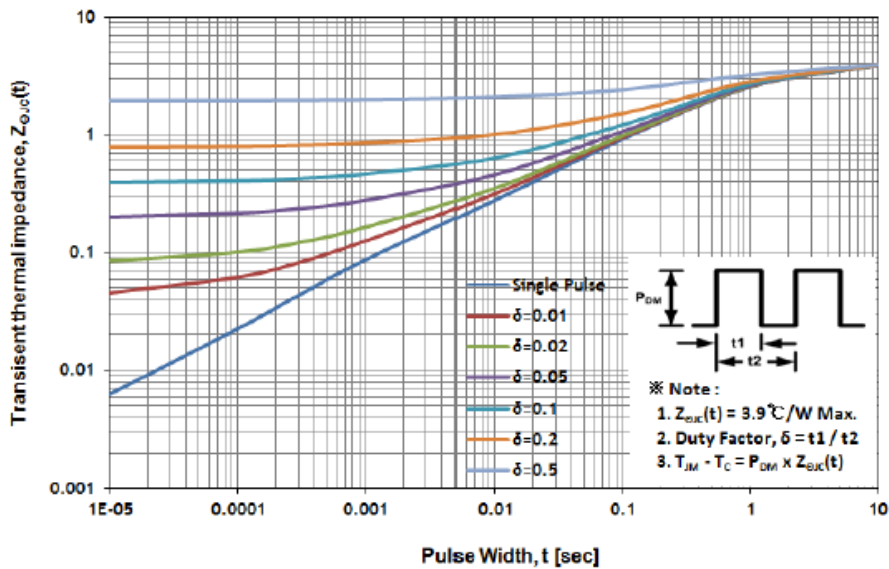
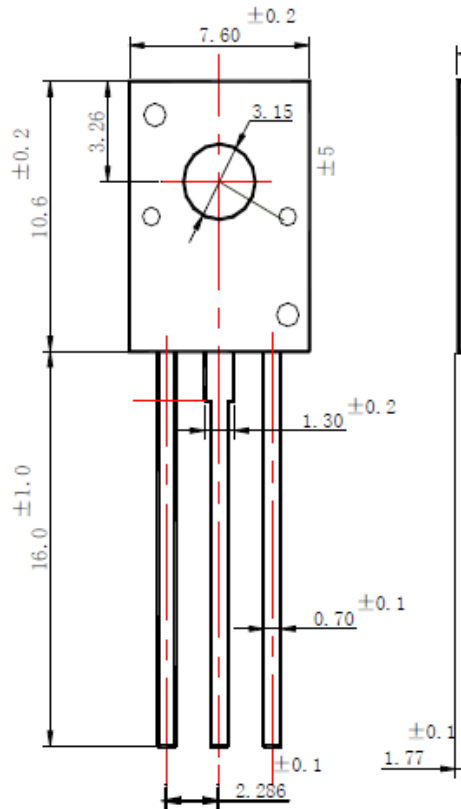

Fig. 11 Transient Thermal Impedance



**Outline Dimension : TO-126F**



Unit : mm

**Marking Diagram**



First Line	WTC	Company Name	
Second Line	4N65M	Product Code	
Third Line	FJ0MMS	1st ( Year Code )	A-2010 B-2011 C-2012 ...
		2nd ( Month Code )	A-Jan B-Feb C-Mar D-Apr E-May F-Jun G-Jul H-Aug I-Sep J-Oct K-Nov L-Dec
		3rd ( Lot Code )	0-1 , A-9
		4th (Product Code )	M-MOS , T-Transistor
		5th (Package Code )	M-TO-126F
		6th ( Spec Code )	( Reserve )