

High Voltage NPN Power Transistor

Features

- High Voltage
- High Switch Speed
- $BV_{CEO} : 400V$
- $BV_{CBO} : 700V$
- $I_C : 3A$
- $V_{CE(SAT)} : 2V @ I_C / I_B = 2A / 0.5A$

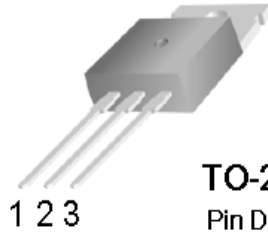

TO-220

- Pin Definition
1. Base
 2. Collector
 3. Emitter

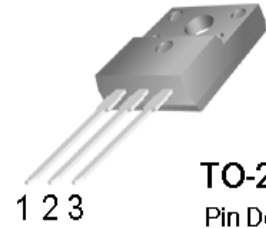

TO-220F

- Pin Definition
1. Base
 2. Collector
 3. Emitter

Application

- Electronic Ballasts
- Adapter
- Lighting

INTERNAL SCHEMATIC DIAGRAM

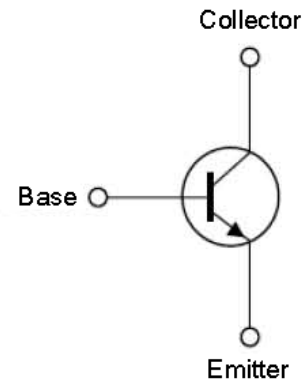

ABSOLUTE MAXIMUM RATINGS ($T_a = 25^\circ C$)

Parameter	Symbol	Limit	Unit
Collector-Base Voltage	V_{CBO}	700	V
Collector-Emitter Voltage	V_{CEO}	400	V
Collect-Break Down Voltage	V_{CES}	700	V
Emitter-Base Voltage	V_{EBO}	9	V
Total Power Dissipation @ $T_c \leq 25^\circ C$ / TO-220	P_{tot}	60	W
Total Power Dissipation @ $T_c \leq 25^\circ C$ / TO-220F	P_{tot}	28	W
Collector Peak Current ($t_p < 5ms$)	I_{CM}	6	A
Collector Current	I_C	3	A
Base Peak Current ($t_p < 5ms$)	I_{BM}	3	A
Base Current	I_B	1.5	A
Maximum Operating Junction Temperature	T_J	+150	$^\circ C$
Operating Junction and Storage Temperature Range	T_{STG}	-65 ~ +150	$^\circ C$

Note: Single Pulse. $P_w=300\mu S$, Duty $\leq 2\%$

ELECTRICAL SPECIFICATIONS

Parameter	Symbol	Test Condition	Min	Typ	Max	Unit
Collector-Base Voltage	BVCBO	IC = 10mA, IB=0	700	—	—	V
Collector-Emitter Breakdown Voltage	BVCEO	IC = 5mA, IE=0	400	—	—	V
Emitter- Base Breakdown Voltage	BVEBO	IE = 1mA, IC=0	9	—	—	V
Collector Cutoff Current	ICBO	VCB = 700V, IE=0	—	—	100	uA
Emitter Cutoff Current	IEBO	VEB = 9V, IC=0	—	—	10	uA
DC Current Gain	hFE1	VCE = 5V, IC=10mA	10	—	—	
	hFE2	VCE = 5V, IC=1A	10	—	30	
	hFE3	VCE = 5V, IC=2A	4	—	—	
Collector-Emitter Saturation Voltage	VCE(SAT1)	IC = 1A, IB =0.25A	—	—	0.9	V
	VCE(SAT2)	IC = 1.5A, IB =0.5A	—	—	1.3	
Frequency	f _f	VCE = 10V, IC=0.1A	4	—	—	MHz
Output Capacitance	Cob	VCB = 10V, IC=0.1MHz	—	21	—	pF
Turn On Time	t _{on}	Vcc = 125V, Ic = 1A, IB1=1B2=0.2A, RL=125ohm	—	0.4	—	uS
Storage Time	t _{STG}		—	2.0	5	uS
Fall Time	t _f		—	0.16	—	uS

Note: Pulse test: pulse width \leq 300uS, duty cycle \leq 2%

Thermal Performance

Parameter	Symbol	Limit	Unit
Junction to Case Thermal Resistance TO-220	R θ_{JC}	2.08	°C/W
Junction to Case Thermal Resistance TO-220F	R θ_{JC}	4.46	°C/W

Electrical Characteristics Curve ($T_a = 25^\circ\text{C}$, unless otherwise noted)

$V_{CE(SAT)}$ V.S. $V_{BE(SAT)}$

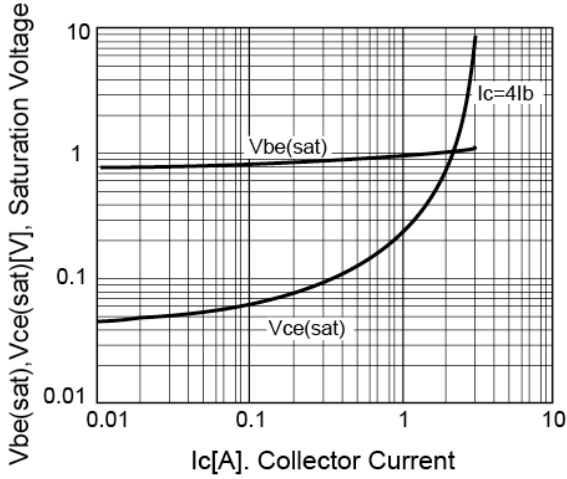

Power Derating

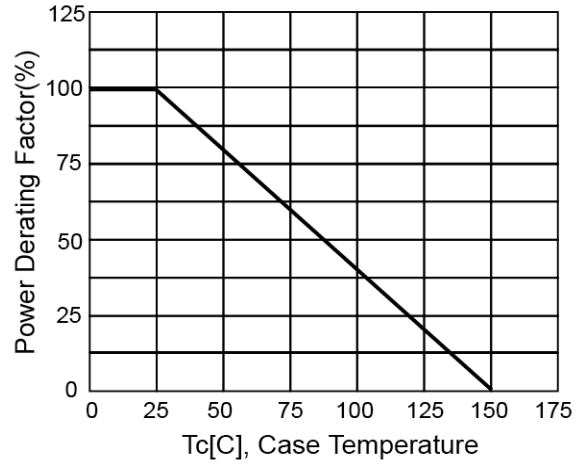

Static Characteristics

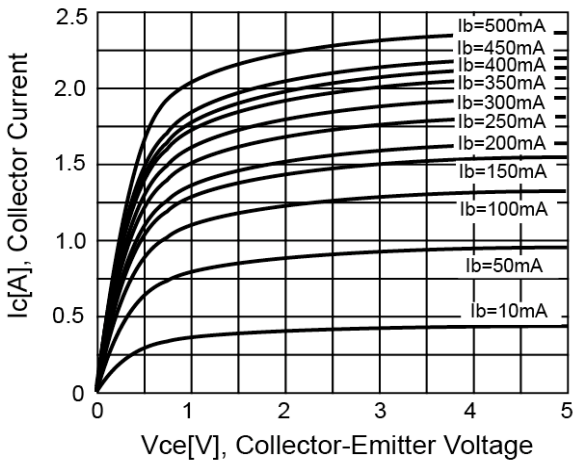

DC Current Gain

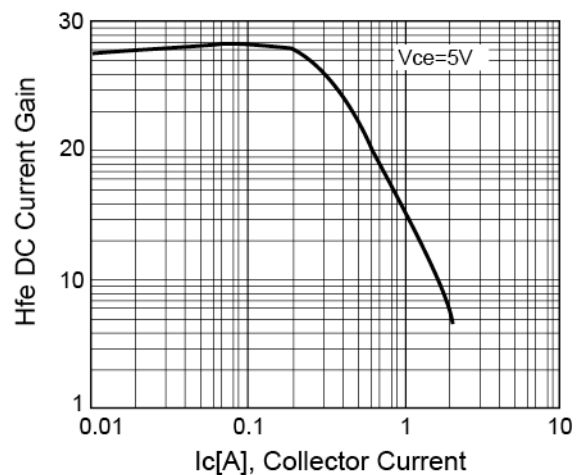

Reverse Bias SOA

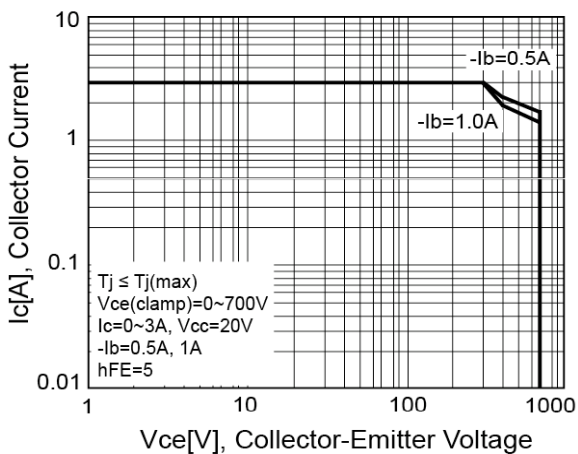

Safety Operating Area

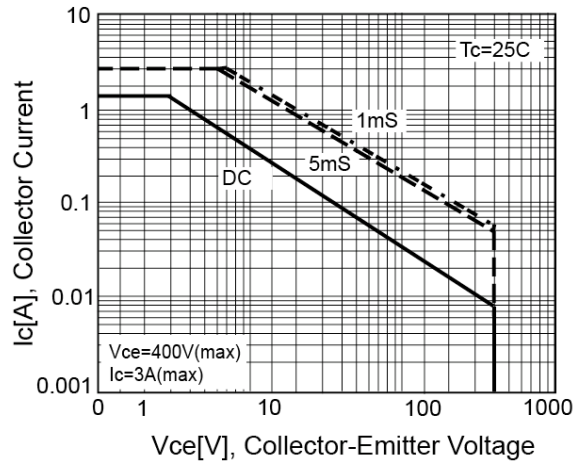

Ordering Information

Type NO	Marking	Package Code
WTX168	168X	TO-220

Marking and Pin Define

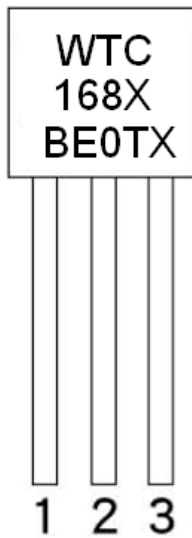

First Line	WTC	Company Name	
Second Line	168X	Product Code	
Third Line	BE0TX	1st (Year Code)	A-2010 B-2011 C-2012 ...
		2nd (Month Code)	A-Jan, B-Feb, C-Mar, D-Apr, E-May, F-Jun, G-Jul, H-Aug, I-Sep, J-Oct, K-Nov, L-Dec
		3rd (Lot Code)	0~1, A~9
		4th (Product Code)	M-MOS, T-Transistor
		5th (Package Code)	I-T0251, D-T0252, L-T092, M-T0126, X-T0220
		6th (Spec Code)	(Reserve)

TO-220 Package Dimension

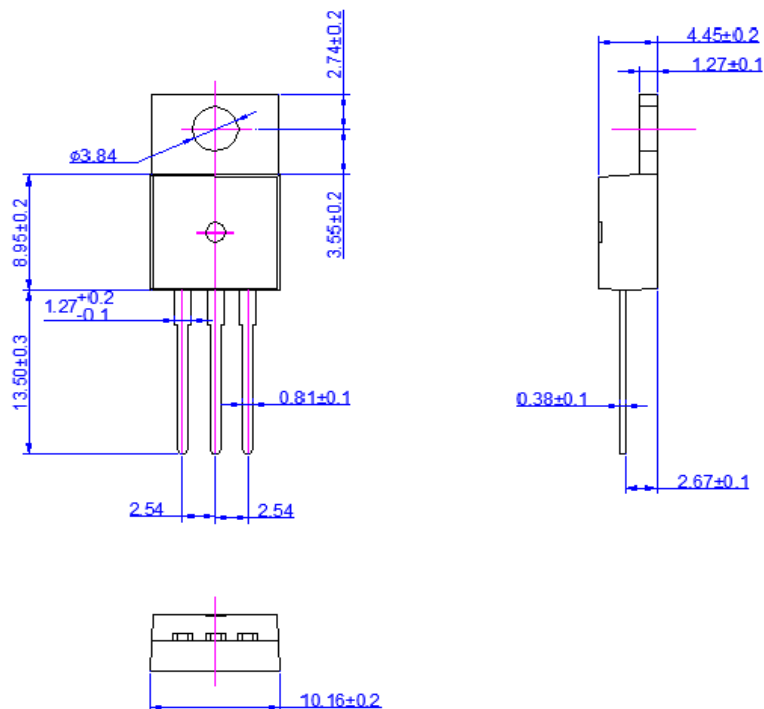

Ordering Information

Type NO	Marking	Package Code
WTF168	168F	TO-220F

Marking and Pin Define

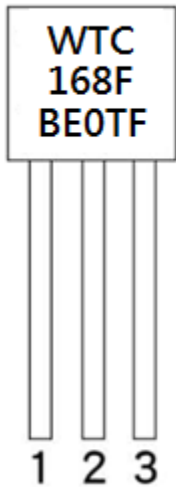

First Line	WTC	Company Name	
Second Line	168F	Product Code	
Third Line	B B 0 T X	1st (Year Code)	A-2010 B-2011 C-2012 D-2013 ...
		2nd (Month Code)	A-Jan, B-Feb, C-Mar, D-Apr E-May, F-Jun, G-Jul, H-Aug, I-Sep, J-Oct, K-Nov, L-Dec
		3rd (Lot Code)	0-9, A-Z
		4th (Product Code)	M - MOS, T - Transistor, L - Linear
		5th (Package Code)	I - TO251, D - TO252, L - TO92 M - TO126, X - TO220, F - TO220F, Y - SOT89, S - SOP3
		6th (Spec Code)	Assembly Code

TO-220F Package Dimension

