

High Voltage NPN Power Transistor

Features

- High Voltage
- High Switch Speed
- $BV_{CEO} : 400V$
- $BV_{CBO} : 700V$
- $I_c : 4A$
- $V_{CE(SAT)} : 1.3V @ I_c / I_B = 2.5A / 0.6A$

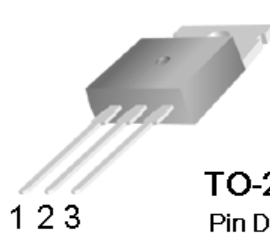

TO-220
Pin Definition
1. Base
2. Collector
3. Emitter

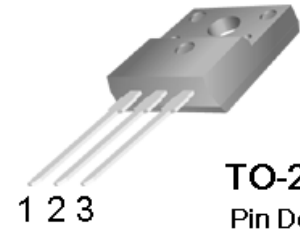

TO-220F
Pin Definition
1. Base
2. Collector
3. Emitter

Application

- Electronic Ballasts
- Adapter
- Lighting

INTERNAL SCHEMATIC DIAGRAM

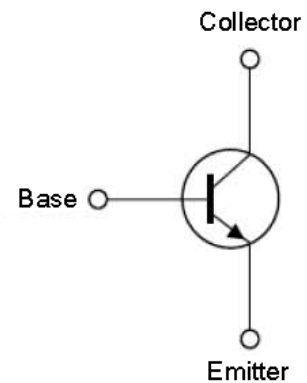

ABSOLUTE MAXIMUM RATINGS ($T_a = 25^{\circ}C$)

Parameter	Symbol	Max rating	Unit
Collector-Base Voltage	V_{CBO}	700	V
Collector-Emitter Voltage	V_{CEO}	400	V
Emitter-Base Voltage	V_{EBO}	9	V
Collector Current (DC)	I_c	4	A
Collector Current (Pulse)		8	
Base Current (DC)	I_B	2	A
Base Current (Pulse)		4	
Total Power Dissipation (TO-220)	P_{Btot}	75	W
Total Power Dissipation (TO-220F)		30	
Junction Temperature	T_J	+150	$^{\circ}C$
Operating Junction and Storage Temperature Range	T_{STG}	-55 ~ +150	$^{\circ}C$

Note: Single Pulse. $P_w=300\mu S$, $Duty \leq 2\%$

ELECTRICAL SPECIFICATIONS

Parameter	Symbol	Test Condition	Min	Typ	Max	Unit
Collector-Base Voltage	BVCBO	IC = 1mA, IB=0	700	–	–	V
Collector-Emitter Breakdown Voltage	BVCEO	IC = 10mA, IE=0	400	–	–	V
Emitter- Base Breakdown Voltage	BVEBO	IE = 0.1mA, IC=0	9	–	–	V
Collector Cutoff Current	ICEO	VCE = 400V, IE=0	–	–	250	uA
Collector Cutoff Current	ICBO	VCB = 700V, IE=0	–	–	1	mA
Emitter Cutoff Current	IEBO	VEB = 9V, IC=0	–	–	1	mA
DC Current Gain	hFE1	VCE = 5V, IC=10mA	15	–	–	V
	hFE2	VCE = 5V, IC=1A	15	–	35	
	hFE3	VCE = 5V, IC=1A	8	–	–	
Collector-Emitter Saturation Voltage	VCE(SAT1)	IC = 0.8A, IB =0.1A	–	–	1.1	V
	VCE(SAT2)	IC = 2A, IB =0.4A	–	–	1.3	
Base-Emitter Saturation Voltage	VBE(SAT1)	IC = 1A, IB =0.2A	–	–	1.2	V
	VBE(SAT2)	IC = 2A, IB =0.4A	–	–	1.3	
Turn On Time	t _{on}	Vcc = 125V, Ic = 2A, IB1=1B2=0.4A, tp=25uS Duty Cycle ≤ 1%	–	0.2	0.5	uS
Storage Time	t _{STG}		–	2.2	3	uS
Fall Time	t _f		–	0.2	0.5	uS

Dynamic

Parameter	Symbol	Test Condition	Min	Typ	Max	Unit
Frequency	f _r	VCE = 10V, IC=0.5A	4	–	–	MHz
Output Capacitance	Cob	VCB = 10V, f=0.1MHz	–	65	–	pF

Note: Pulse test: pulse width ≤ 300uS, duty cycle ≤ 2%

Electrical Characteristics Curve (Ta = 25°C, unless otherwise noted)

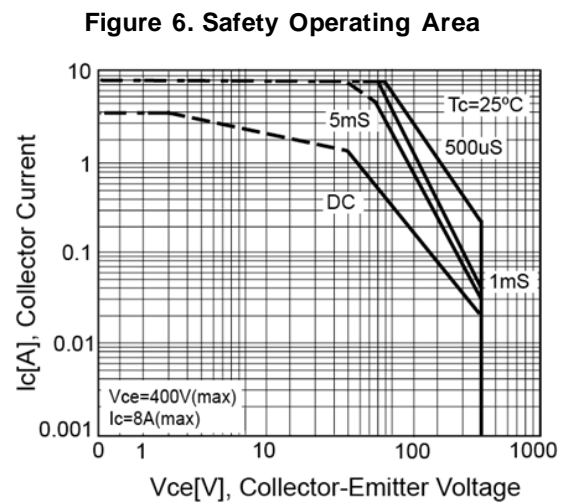
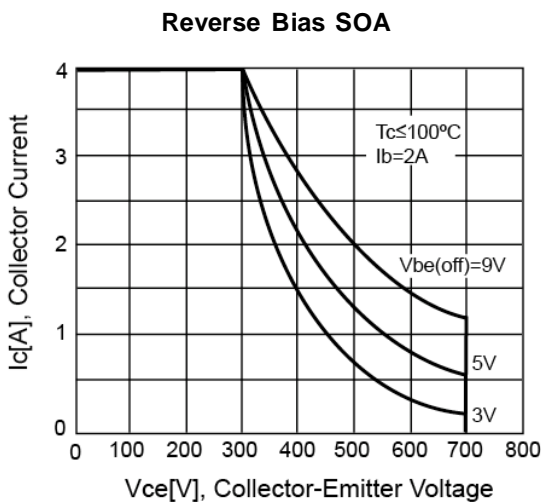
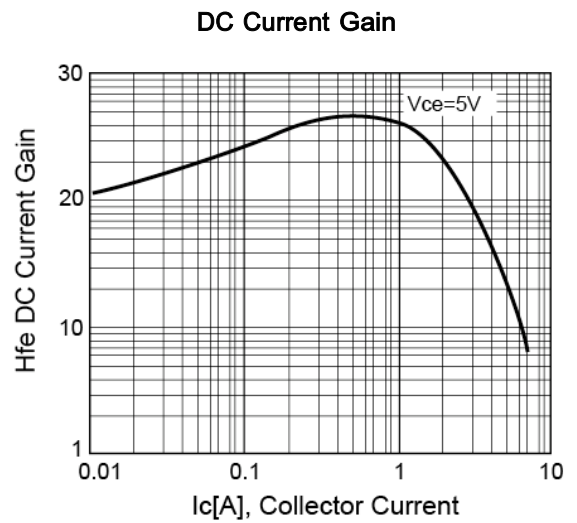
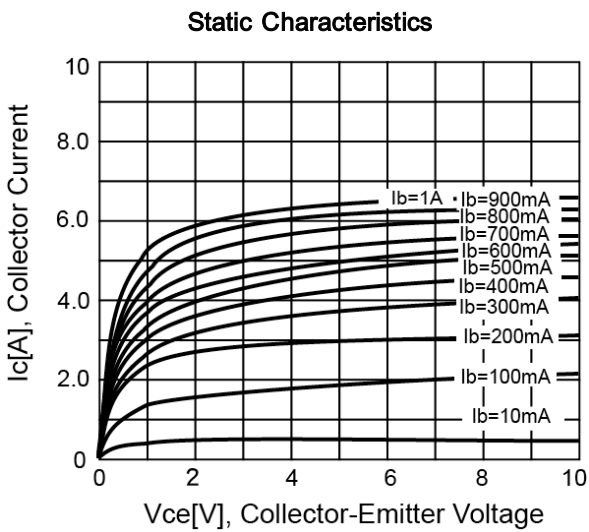
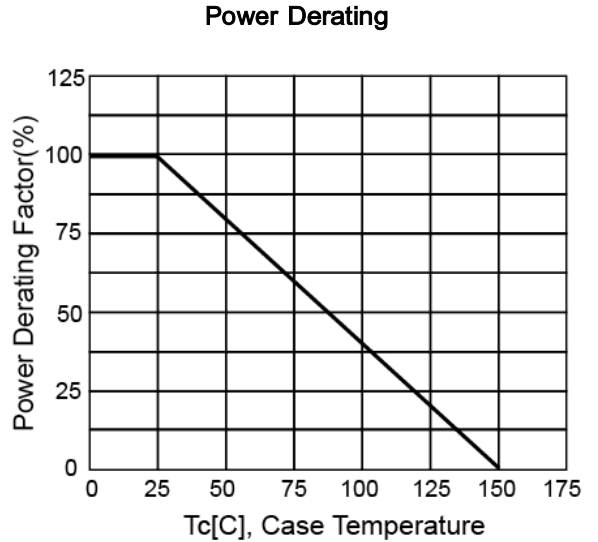
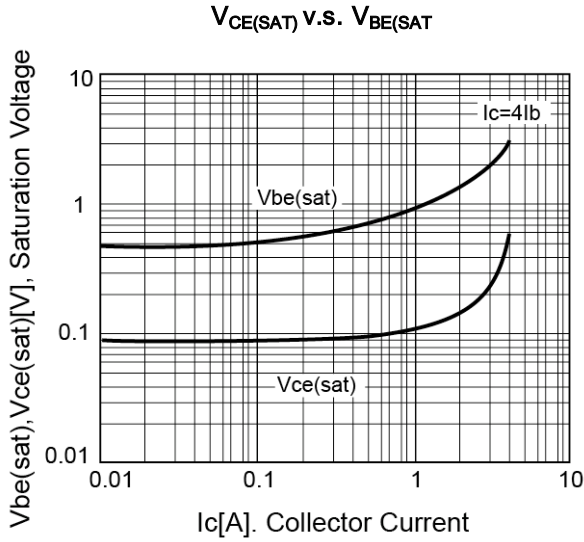

Ordering Information

Type NO	Marking	Package Code
WTX268	268X	TO-220

Marking and Pin Define

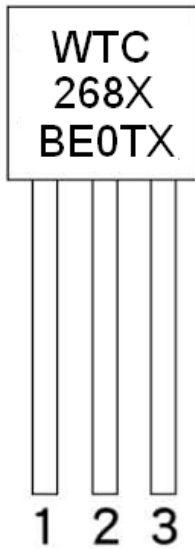

First Line	WTC	Company Name	
Second Line	268X	Product Code	
Third Line	BE0TX	1st (Year Code)	A-2010 B-2011 C-2012 ...
		2nd (Month Code)	A-Jan, B-Feb, C-Mar, D-Apr, E-May, F-Jun, G-Jul, H-Aug, I-Sep, J-Oct, K-Nov, L-Dec
		3rd (Lot Code)	0~1, A~9
		4th (Product Code)	M-MOS, T-Transistor
		5th (Package Code)	I-T0251, D-T0252, L-T092, M-T0126, X-T0220, F-T0220F
		6th (Spec Code)	(Reserve)

TO-220 Package Dimension

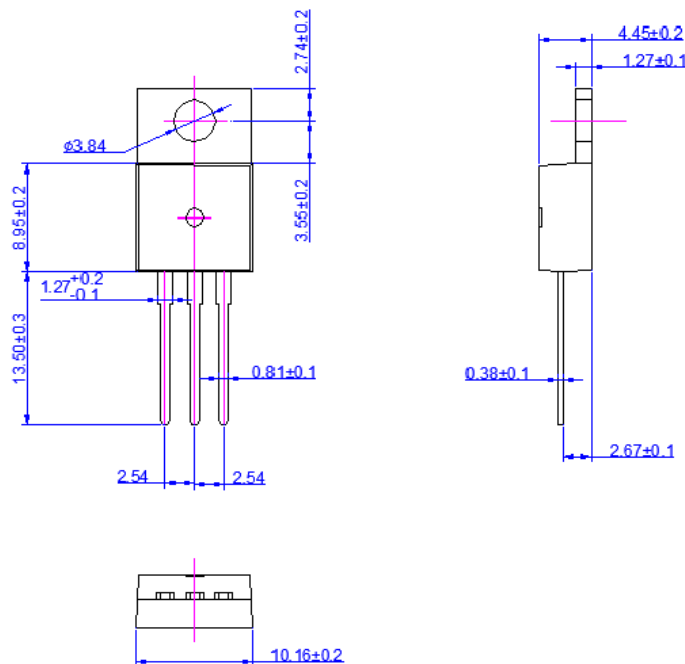

Ordering Information

Type NO	Marking	Package Code
WTF268	268F	TO-220F

Marking and Pin Define

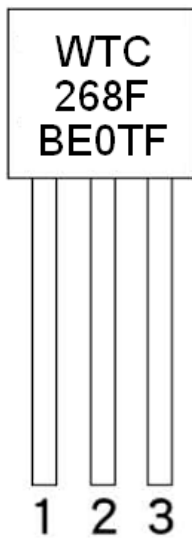

First Line	WTC	Company Name	
Second Line	268F	Product Code	
Third Line	BE0TF	1st (Year Code)	A-2010 B-2011 C-2012 ...
		2nd (Month Code)	A-Jan, B-Feb, C-Mar, D-Apr, E-May, F-Jun, G-Jul, H-Aug, I-Sep, J-Oct, K-Nov, L-Dec
		3rd (Lot Code)	0~1, A~9
		4th (Product Code)	M-MOS, T-Transistor
		5th (Package Code)	I-T0251, D-T0252, L-T092, M-T0126, X-T0220, F-T0220F
		6th (Spec Code)	(Reserve)

TO-220F Package Dimension

